

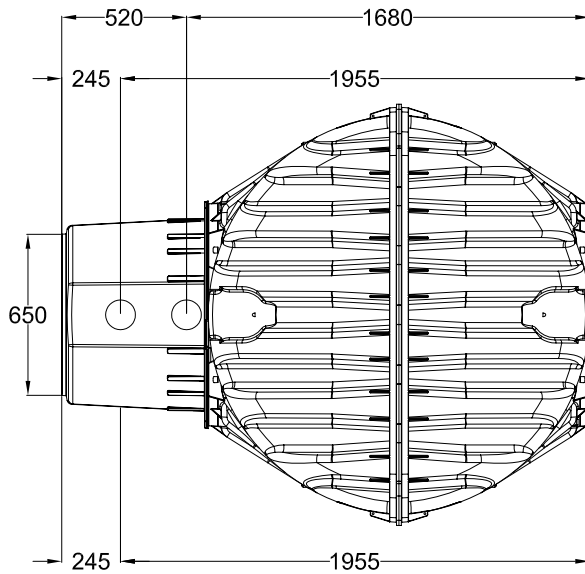

Regenwasser-Erdtank-Carat -S- 3750 I
Rainwater underground tank Carat -S- 3750 I

Artikel-Nr.
Item no.

372002



Otto Graf GmbH esindaja Eestis on
Puhastid OÜ
+372 5322 5822, info@puhastid.ee

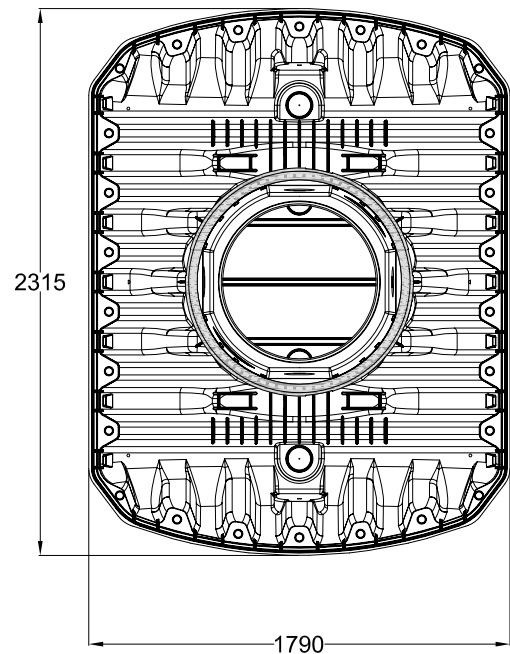
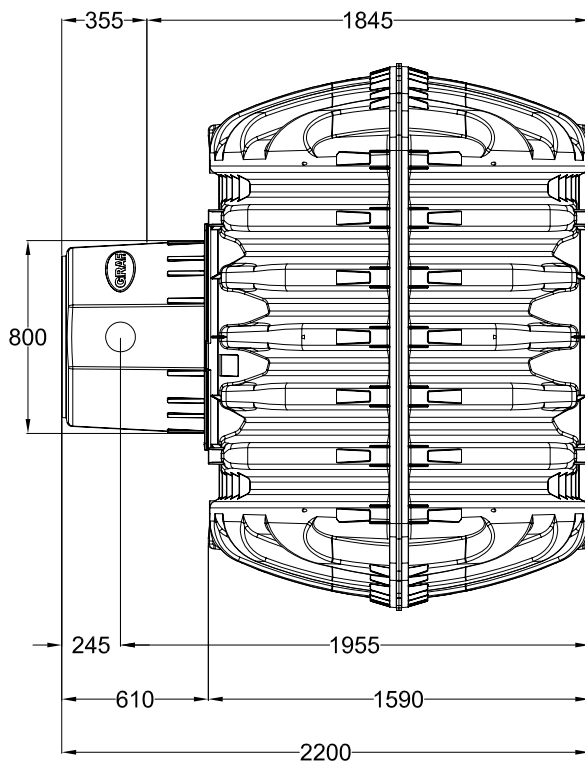

alle Maße +/- 3 % Toleranz
all dimensions +/- 3% tolerance

Otto Graf GmbH
Kunststofferzeugnisse
79331 Teningen

Carl-Zeiss-Str. 2-6
Telefon 07641/589-0
Telefax 07641/589-50
Email: info@graf-online.de
www.graf-online.de

Datum/date

Name/name

Gewicht/weight 150 kg

Ausgabe/edition 01/07

Blatt/page 1 von 1